

# REFU<sup>sol</sup> 100K

The next generation of solar string inverters

SUITABLE FOR  
REPOWERING  
APPLICATIONS

- High design flexibility
- Best serviceability
- Maximum power density
- Minimized BOS costs

With maximum power density, REFU's next generation inverter family combines compatibility, installation flexibility, serviceability, and connectivity in a revolutionary design.

**Compatibility:** This inverter can be connected to any grid voltage between 200 and 460 VAC, offering maximum power between 48 and 100 kVA.

**Installation Flexibility:** The inverter can be mounted in a vertical or horizontal position as demanded on site. The roomy ConnectionBox is available with either fused direct string connections for decentralized designs, or with single DC input for centralized designs.

**Serviceability:** The PowerUnit can be quickly detached from the ConnectionBox for trouble-shooting and measurements without disconnecting the power cables on the DC or AC side.

**Connectivity:** The inverter can be commissioned via the REFUset app (available for iOS and Android) which connects seamlessly via Bluetooth® to the inverter. The integrated, fail-safe Ethernet daisy chain (alternatively RS485) allows cost efficient high-speed monitoring without special accessories. Each inverter can be individually connected to the REFUlog portal for remote monitoring, configuration, and updates.



<b>Art. No.</b>	<b>REFUso1 100K</b>			
<b>Operation Mode</b>	<b>880P100.010</b>			
	<b>83 kVA @ 380 VAC</b>	<b>88 kVA @ 400 VAC</b>	<b>92 kVA @ 415 VAC</b>	<b>100 kVA @ 460 VAC</b>

## DC DATA

Max. voltage DC (V)	1,100			
Nominal voltage DC (V)	600	620	640	695
MPPT range at nominal power (V)	555... 900	585... 900	605... 900	665... 900
MPP range (V)	555... 1,000	585... 1,000	605... 1,000	665... 1,000
DC start-up open circuit voltage (V)	595	625	650	720
Max. operational current DC (A)	154	155	154	153
Max. short circuit current ISC of PV system (A)	250			
Max. short circuit current ISC per String input (A)	25			
Max. DC/AC power ratio (%)	150			
Backfeed current (A)	0			
Rated input power	85.5	90.5	94.5	102.5
MPP trackers	1			
DC connection Inverter-ConnectionBox	1 Plus, 1 Minus: Connector with Button Activated Coupling			

## AC DATA

AC rated power (kVA)	83.3	88.0	92.0	100.0
Rated voltage AC (V)	380	400	415	460
Voltage range AC (V)	180... 528			
AC grid connection/ Grid types	3 Phases, PE / TT, TN-C, TN-S			
Nominal power factor / Range	1 / 0.3i... 0.3c			
Rated frequency / Frequency range (Hz)	50, 60 / 45... 65			
Max. AC current (A)	128			
Max. AC short circuit current (Arms)	64 [3 period average]			
Inrush current (peak / duration)	25 A / 0.5 ms			
Max. THD (%)	< 3			
Max. efficiency (%)	98.3	98.4	98.4	98.5
European efficiency (%)	97.9	98.0	98.0	98.1
Night-time power loss (W)	< 1			
Maximum admissible external AC fuse	160 A (consider the triggering characteristic), gG, UN = 500 V			
Peak current (Ip) / Initial short circuit current (Ik") acc. IEC 60690-0 (A)	128 / 325			
AC connection PowerUnit-ConnectionBox	Connector with Button Activated Coupling			

## AMBIENT CONDITIONS

Cooling	Smart active cooling			
Max. temp. for nominal power (°C)	45			
Ambient temperature (°C)	- 25...+ 60			
Rel. air humidity (%)	0... 100			
Max. elevation (m above sea level)	3,000			
Noise level (dBA)	< 70			
Environment classification (IEC 60721-3-4)	4K4H			
Type of protection PowerUnit / ConnectionBox (IEC 60529)	IP65 / IP54			
Installation type	Indoor/outdoor, Vertical / horizontal / pole mounting			

Art. No.

**REFU<sub>sol</sub> 100K**  
**880P100.010**

Operation Mode

83 kVA @ 380 VAC    88 kVA @ 400 VAC    92 kVA @ 415 VAC    100 kVA @ 460 VAC

## SAFETY AND PROTECTION FUNCTIONS

Safety and protection devices	Refer to ConnectionBox
Grid monitoring	Voltage, Frequency, Passive and Active Anti-Islanding, DC injection
Grid separation	Gate Block/Redundant Grid Relay
Residual Current Monitoring (RCD) / Isolation Monitoring	Type 2/yes
Compatibility external RCD	Type A / Type B
Protection class (IEC 62109)	1
Overvoltage category (IEC 60664-1)	DC: II / AC: III

## GENERAL DATA

Topology	Transformerless
DC pole grounding	not allowed
Status display / Keys	4 LED's (DC status, AC status, Fault, Bluetooth®) / 2 Keys (Connect, Clear)
Interfaces	2 × Ethernet Daisy-Chain / 2 × RS485, Bluetooth® BLE, 1 × Remote Off Signal
Communication Protocols	Sunspec (Modbus TCP, Modbus RTU), USS (Ethernet, RS485)
Dimensions W × H × D (mm)	673 × 626 × 321
Weight (kg)	69

## CERTIFICATES\*

EU Directive	2006/95/EC, 2004/108/EC
Product	IEC 62109-1, IEC 62109-2, IEC 62116, IEC 61727, IEC 61683, IEC 62477-1
EMC	IEC 61000-6-2, IEC 61000-6-4
Environment	IEC 60068-2-1, -2-2, -2-30, -2-78, -2-14, -2-6, -2-27, -3-2, -2-75, IEC 60529, IEC 60034-9
Grid Codes	DIN VDE V 0126-1-1, VDE AR-N 4105, BDEW Prototype Declaration, TOR D4, Önorm E 8001-4-712, UTE C15-712-1, EN 50438

\*All certificates are available at [www.refu.com](http://www.refu.com)

## EFFICIENCY

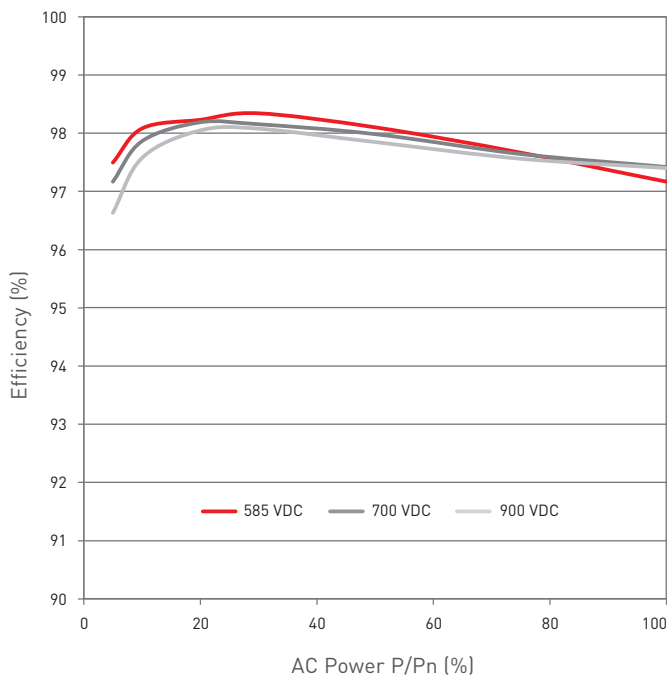

## POWER DERATING

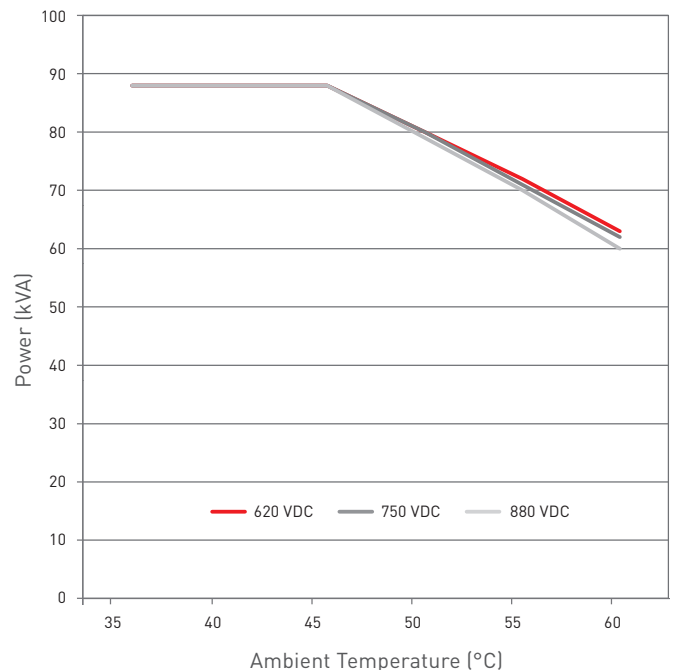

Type	Decentral ConnectionBox		Central ConnectionBox	
	CBID 100K (1100V-PM-DCS)	CBID 100K (1100V-PM-DCS-ACS)	CBIC 100K (1100V-R-DCS)	CBIC 100K (1100V-R-DCS-ACS)
Art. No. (with Push in Clamps)	937P211.0001	937P211.0011	936P001.0000	936P001.0010
Art. No. (with MC4 connectors)	937P111.0001	937P111.0011	-	-

**INPUT**

Rated DC voltage (V)	1,100	1,100
Max. current per input / total (A)	25/250	250/250
DC connection (+/-)	20 Strings Push in Clamp 0.5 ... 16 mm <sup>2</sup> / 20 Strings MC4	Ring terminal block (50 ... 240 mm <sup>2</sup> )
DC fuses	Plus and Minus integrated (gPV, 15A, 1,100 VDC, 14 x 51 mm)	-
DC circuit breaker	integrated	integrated
DC overvoltage protection	Order separately (Art. No. 922021 / 22)	Order separately (Art. No. 922021 / 22)

**OUTPUT**

AC overvoltage protection	Order separately (Art. No. 922023 / 24)	Not available
AC circuit breaker	none	integrated
AC connection	L1, L2, L3: M12 PE: M10 Bolt Terminals 50 ... 240 mm <sup>2</sup>	L1, L2, L3: M10 PE: M8 Bolt Terminals 50 ... 150 mm <sup>2</sup>

**GENERAL DATA**

Dimensions W x H x D (mm)	760 x 1007 x 166	760 x 692 x 166
Weight (kg)	40	25

**OPTIONAL ACCESSORIES**

Art. No.	Option Name	Contents
922021	DC SPD Type 2 Kit	DC SPD Type 2 Cartridge (2 Pcs.)
922022	DC SPD Type 1+2 Kit	DC SPD Type 1+2 Cartridge (2 Pcs.)
922023	AC SPD Type 2 Kit	AC SPD Type 2 Cartridge (3 Pcs.) Fuse (3 Pcs.), Screw Cap (3 Pcs.)
922024	AC SPD Type 1+2 Kit	AC SPD Type 1+2 Cartridge (3 Pcs.) Fuse (3 Pcs.), Screw Cap (3 Pcs.)

**DECENTRAL CONNECTIONBOX**

(DIRECT STRING CONNECTIONS)

**CENTRAL CONNECTIONBOX**

(EXTERNAL DC COMBINER BOX REQUIRED)

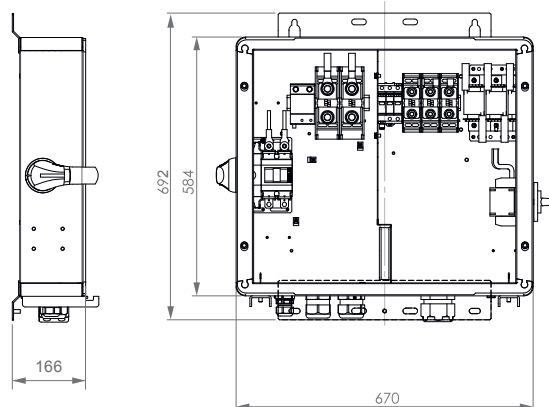
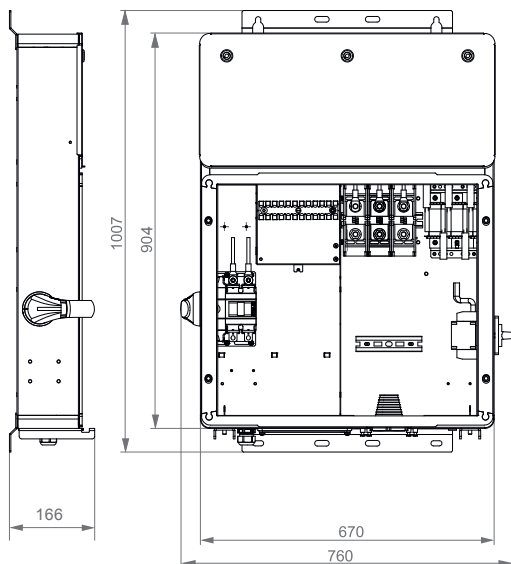

OVERALL SYSTEM

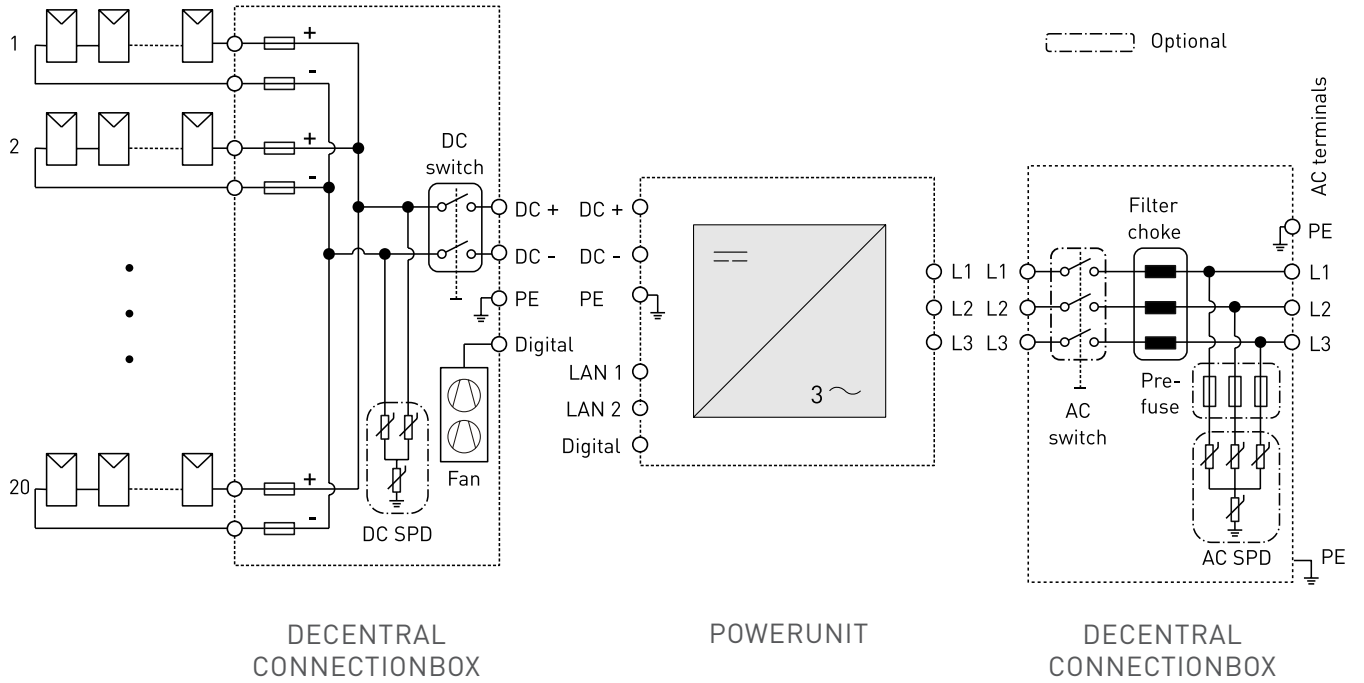

POWERUNIT

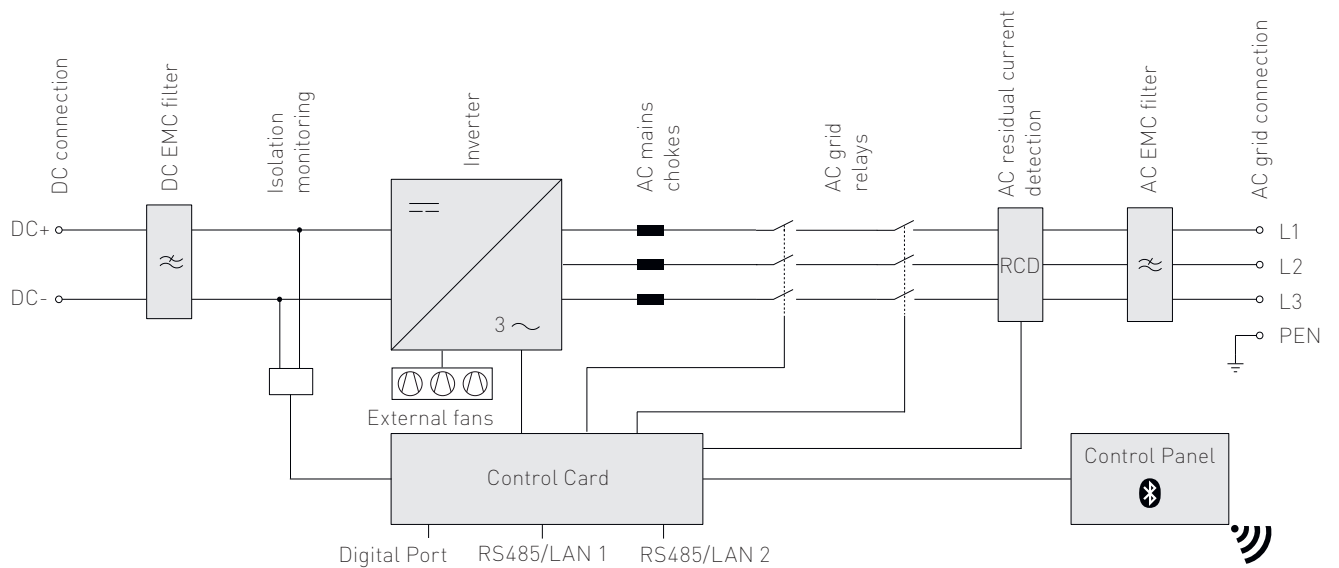

## FLEXIBLE INSTALLATION POSSIBILITIES

REFU's next generation platform support different plant designs from large commercial rooftops to multi-MW ground mount systems. You can choose to place the inverter being near the solar panels (decentralized) or near the transformer station (centralized).

### DECENTRALIZED VARIANT

GROUND MOUNTED SYSTEMS

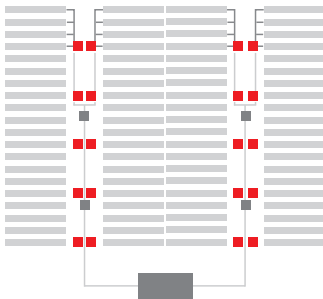

ROOFTOP SYSTEMS

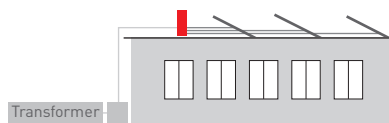

### CENTRALIZED VARIANT

GROUND MOUNTED SYSTEMS

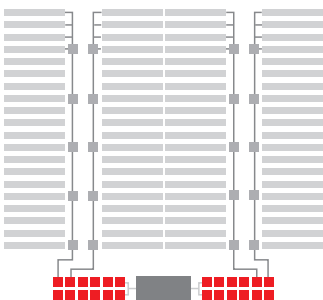

ROOFTOP SYSTEMS

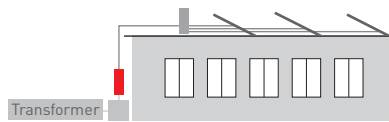

■ REFU sol inverter ■ DC combiner box ■ AC combiner — DC cable — AC cable

## INSTALLATION MADE EASY

Vertical, horizontal and pole mounting are made possible by the new design of the REFU's next generation inverter platform which is super flexible. The ConnectionBox and PowerUnit can be delivered individually in separate shipments. The ConnectionBox can be installed during cable work, and the PowerUnit just before commissioning thereby optimizing your investment and project cash flow.

1

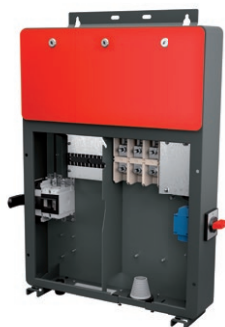

Install and wire the ConnectionBox.

2



Hang in PowerUnit before commissioning.

3



Start feed-in.

No responsibility is taken for the correctness of this information. Subject to modification.

REFU Elektronik GmbH | Marktstraße 185 | 72793 Pfullingen | Germany | Tel. +49 7121 4332-0 | Fax +49 7121 4332-140 | info@refu.com | www.refu.com